

MEM Deck-mounted basin spout with pop-up waste - Brushed Champagne (22kt Gold)









MEM

13 715 782



- 200mm projection
- fixed spout
- rectangular, air-enriched flow
- height of mixer 321 mm
- height up to aerator 190 mm
- hole diameter 35 mm
- 2x screw-in M 10 x 1 pressure hose, leak-tested
- rosette 60 x 60 mm
- max. flow 5.7 l/min
- lead-free
- This product can help a building meet the requirements of Green Building Rating Systems, e.g. LEED®, BREEAM®, DGNB

Only suitable for basins with an overflow.

	Brushed Champagne (22kt Gold)	13 715 782-46
	Chrome	13 715 782-00
	Brushed Platinum	13 715 782-06
	Platinum	13 715 782-08
	Dark Chrome	13 715 782-19
	Brushed Durabronze (23kt Gold)	13 715 782-28
	Champagne (22kt Gold)	13 715 782-47
	Brushed Dark Platinum	13 715 782-99

13 715 782
mm [inches]

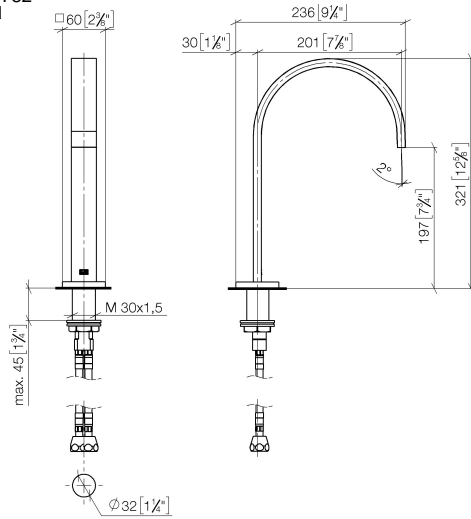

Flow rate chart



Certificates

GDV_0400289.

**MEM Deck-mounted basin spout with pop-up waste - Brushed Champagne
(22kt Gold)**

MEM

13 715 782
Parts for other
finishes can be found
here: [Chrome](#)

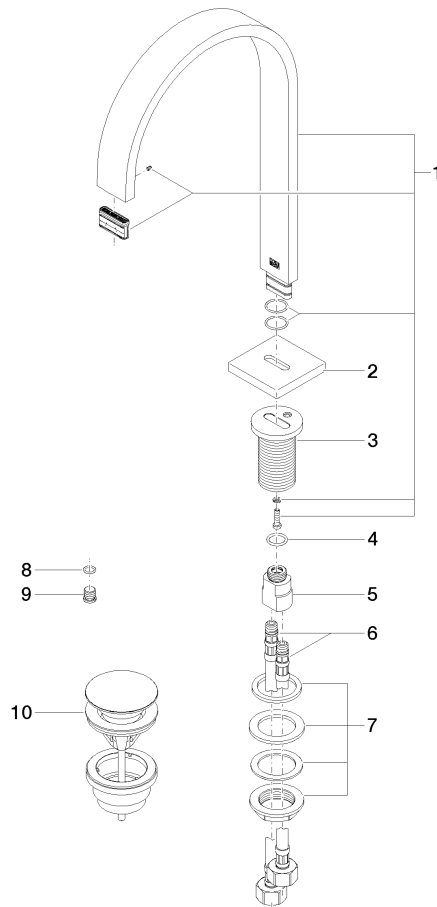

Spare parts list

No.	Item Number	Name	Quantity used	Delivery time
1	90 28 22 155 01-46	spout	1	30
2	09 27 78 034-46	rosette	1	30
3	09 11 10 054 10 90	connection	1	2
4	09 14 10 130 90	seal	1	2
5	09 11 10 055 10 90	connection	1	2
6	04 30 04 019 00 90	hose	2	2
7	04 23 10 009 01 90	fixing set	1	2
8	90 14 10 060 00 90	seal	1	2
9	09 31 20 065 90	plug	1	2
10	10 125 970-46	Basin Waste with push fastening 1 1/4" - Brushed Champagne (22kt Gold)	1	30